

TOSHIBA

DVD PLAYER

OWNER'S MANUAL

MODEL : SD-2705



Before connecting, operating or adjusting this product,
please read this instruction booklet carefully and completely.

Safety Precautions

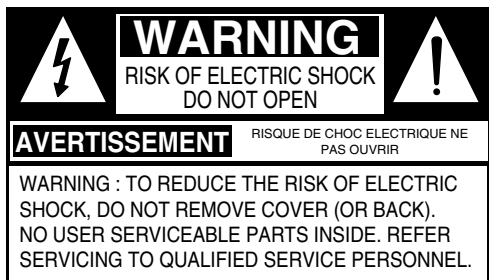

The lightning flash with arrowhead symbol, within an equilateral triangle, is intended to alert the user to the presence of uninsulated 'dangerous voltage' within the product's enclosure that may be of sufficient magnitude to constitute a risk of electric shock to persons.



The exclamation point within an equilateral triangle is intended to alert the user to the presence of important operating and maintenance (servicing) instructions in the literature accompanying the appliance.

WARNING: TO REDUCE THE RISK OF FIRE OR ELECTRIC SHOCK, DO NOT EXPOSE THIS PRODUCT TO RAIN OR MOISTURE.

CAUTION: TO PREVENT ELECTRIC SHOCK, MATCH WIDE BLADE OF PLUG TO WIDE SLOT, FULLY INSERT.

ATTENTION: POUR EVITER LES CHOC ELECTRIQUE, INTRODUIRE LA LAME LA PLUS LARGE DE LA FICHE DANS LA BORNE CORRESPONDANTE DE LA PRISE ET POUSSER JUSQU'AU FOND.

CAUTION: This Digital Video Disc Player employs a Laser System. To ensure proper use of this product, please read this owner's manual carefully and retain for future reference. Should the unit require maintenance, contact an authorized service location-see service procedure.

Use of controls, adjustments or the performance of procedures other than those specified may result in hazardous radiation exposure.

To prevent direct exposure to laser beam, do not try to open the enclosure. Visible laser radiation is present when the enclosure is opened. DO NOT STARE INTO BEAM.

FCC NOTICE: This equipment has been tested and found to comply with the limits for a Class B digital device, pursuant to part 15 of the FCC Rules. These limits are designed to provide reasonable protection against harmful interference in a residential installation.

This equipment generates, uses, and can radiate radio frequency energy and, if not installed and used in accordance with the instructions, may cause harmful interference to radio communications. There is no guarantee that interference will not occur in a particular installation.

If this equipment does cause harmful interference to radio or television reception, which can be determined by turning the equipment off and on, the user is encouraged to try to correct the interference by one or more of the following measures:

- Reorient or relocate the receiving antenna.
- Increase the separation between the equipment and receiver.
- Connect the equipment into an outlet on a circuit different from that to which the receiver is connected.
- Consult the dealer or an experienced radio/TV technician for help.

FCC WARNING: Changes or modifications not expressly approved by the party responsible for compliance could void the user's authority to operate the equipment.

INDUSTRY CANADA REQUIREMENT :

This Class B digital apparatus meets all requirements of the Canadian Interference-Causing Equipment Regulations.

Cet appareil numéruque de la classe B respecte toutes les exigences du Règlement sur le matériel brouilleur du Canada.

RECORD YOUR MODEL NUMBER (Now, while you can see it)

The model and serial number of your new DVD player are located on the back of the DVD player cabinet. For your future convenience, we suggest that you record these numbers here:

MODEL NO. _____

SERIAL NO. _____

Table of Contents

Introduction

- ❑ Safety Precautions 2
- ❑ Table of Contents 3
- ❑ IMPORTANT SAFETY INSTRUCTIONS 4-5
- ❑ Precautions 6
- ❑ Notes on Discs 7
- ❑ Identification of Controls 8-11
 - Front Panel/Display Window 8
 - Rear Panel 9
 - Remote Control 10
 - Preparing the Remote Control 11
 - Operating with the Remote Control 11

Connections

- ❑ Connecting to a TV 12
- ❑ Connecting to an Audio System 13
- ❑ Connecting to Optional Audio System 14-16
 - Enjoying Dolby Digital Sound 14
 - Enjoying Dolby Pro Logic Surround Sound 15
 - Enjoying 2 Channel Digital Stereo Sound 16
 - Enjoying DTS Sound 16

Basic Operations

- ❑ Basic Playback 17-20
 - Stopping Play 19
 - Resume Play 19
 - Last Scene Memory 19
 - Exchanging Discs during Playback 20
 - Skipping Discs 20
 - Exchanging the Disc and Starting Playback 20
- ❑ Special Playback 21-22
 - Still Picture 21
 - Frame Advance 21
 - Skipping Chapters and Tracks Forward or Back 21
 - To Scan at Fast Forward or Fast Reverse Playback 22
 - Playing in Slow-Motion 22

Operation Using GUI Menu

- ❑ General Information about GUI Menu 23
- ❑ Detailed Description of each GUI Menu Icon 24

Advanced Operation

- ❑ Using a Title Menu 25
- ❑ Using a DVD Menu 25
- ❑ Changing Subtitle Language 26
- ❑ Changing Audio Soundtrack Language 26
- ❑ Viewing Multi Angle Discs 27
- ❑ Producing a 3D Surround Effect 27
- ❑ Repeat Play 28
- ❑ Storing Markers in Memory to be Viewed or
Listened to again 29
- ❑ Zoom Feature 30
- ❑ Random Play 30
- ❑ Program Play 31

Initial Settings

- ❑ Selection of Initial Settings 32
- ❑ Selecting Disc Languages 33
- ❑ Selecting Rating Level and Password 34-35
- ❑ Selecting TV Aspect 36
- ❑ Selecting Menu Language 37
- ❑ Selecting Digital Audio Output 38
- ❑ Others (DRC/Vocal/PBC) 39
- ❑ Table of Languages and Their Abbreviations 40

Reference

- ❑ Disc Requirements/Copyright Information 41
- ❑ Before Calling Service Personnel 42
- ❑ Specifications 43

Others

- ❑ LIMITED WARRANTY DVD VIDEO PLAYER 44-45

IMPORTANT SAFETY INSTRUCTIONS

CAUTION: PLEASE READ AND OBSERVE ALL WARNINGS AND INSTRUCTIONS IN THIS OWNER'S MANUAL AND THOSE MARKED ON THE UNIT. RETAIN THIS BOOKLET FOR FUTURE REFERENCE.

This set has been designed and manufactured to assure personal safety. Improper use can result in electric shock or fire hazard. The safeguards incorporated in this unit will protect you if you observe the following procedures for installation, use and servicing.

This unit is fully transistorized and does not contain any parts that can be repaired by the user.

DO NOT REMOVE THE CABINET COVER, OR YOU MAY BE EXPOSED TO DANGEROUS VOLTAGE. REFER SERVICING TO QUALIFIED SERVICE PERSONNEL ONLY.

1. Read owner's manual

After unpacking this product, read the owner's manual carefully, and follow all operating and related instructions.

2. Power Sources

This product should be operated only from the type of power source indicated on the label. If you are not sure of the type of power supply in your home, consult your product dealer or local power company. For products intended to operate from battery power, or other sources, refer to the operating instructions.

3. Grounding or Polarization

This product is equipped with a polarized alternating current line plug (a plug having one blade wider than the other). This plug will fit into the power outlet only one way. This is a safety feature. If you are unable to insert the plug fully into the outlet, try reversing the plug. If the plug should still fail to fit, contact your electrician to replace your obsolete outlet. Do not defeat the safety purpose of the polarized plug.

4. Ventilation

Slots and openings in the cabinet are provided for ventilation and to ensure reliable operation of the product and to protect it from overheating. These openings must not be blocked or covered. The openings should never be blocked by placing the product on a bed, sofa, rug or other similar surface. This product should not be placed in a built-in installation such as a bookcase or rack unless proper ventilation is provided or the manufacturer's instructions have been adhered to.

5. Heat

The product should be situated away from heat sources such as radiators, heat registers, stoves, or other products (including amplifiers) that produce heat.

6. Water and Moisture

Do not use this product near water—for example, near a bath tub, wash bowl, kitchen sink, or laundry tub; in a wet basement; or near a swimming pool and the like.

7. Cleaning

Unplug this product from the wall outlet before cleaning. Do not use liquid cleaners or aerosol cleaners. Use a damp cloth for cleaning.

8. Power-Cord Protection

Power-supply cords should be routed so that they are not likely to be walked on or pinched by items placed upon or against them, paying particular attention to cords at plugs, convenience receptacles, and the point where they exit from the product.

9. Overloading

Do not overload wall outlets, extension cords, or integrated convenience receptacles as this can result in a risk of fire or electric shock.

10. Lightning

For added protection of this product during storms, or when it is left unattended and unused for long periods of time, unplug it from the wall outlet. This will prevent damage to the product due to lightning and power-line surges.

11. Object and Liquid Entry

Never push objects of any kind into this product through openings as they may touch dangerous voltage points or short-out parts that could result in a fire or electric shock. Never spill liquid of any kind on the product.

12. Attachments

Do not use attachments not recommended by the product manufacturer as they may cause hazards.

IMPORTANT SAFETY INSTRUCTIONS (Cont'd)

13. Accessories

Do not place this product on an unstable cart, stand, tripod, bracket, or table. The product may fall, causing serious injury to a child or adult, and serious damage to the product. Use only with a cart, stand, tripod, bracket, or table recommended by the manufacturer, or sold with the product. Any mounting of the product should follow the manufacturer's instructions, and should use a mounting accessory recommended by the manufacturer. A product and cart combination should be moved with care. Quick stops, excessive force, and uneven surfaces may cause the product and cart combination to overturn.



14. Disc Tray

Keep your fingers well clear of the disc tray as it is closing. It may cause serious personal injury.

15. Burden

Do not place a heavy object on or step on the product. The object may fall, causing serious personal injury and serious damage to the product.

16. Connecting

When you connect the product to other equipment, turn off the power and unplug all of the equipment from the wall outlet. Failure to do so may cause an electric shock and serious personal injury. Read the owner's manual of the other equipment carefully and follow the instructions when making any connections.

17. Sound Volume

Reduce the volume to the minimum level before you turn on the product. Otherwise, sudden high volume sound may cause hearing or speaker damage.

18. Sound Distortion

Do not allow the product to output distorted sound for a prolonged time. It may cause speaker overheating and fire.

19. Headphones

When you use the headphones, keep the volume at a moderate level. If you use the headphones continuously with high volume sound, it may cause hearing damage.

20. Laser Beam

Do not look into the opening of the disc tray or ventilation opening of the product to see the source of the laser beam. It may cause damage to your vision.

21. Disc

Do not use a cracked, deformed, or repaired disc. These discs are easily broken and may cause serious personal injury and product malfunction.

22. Damage Requiring Service

Unplug this product from the wall outlet and refer servicing to qualified service personnel under the following conditions:

- a) When the power-supply cord or plug is damaged.
- b) If liquid has been spilled, or objects have fallen into the product.
- c) If the product has been exposed to rain or water.
- d) If the product does not operate normally by following the operating instructions. Adjust only those controls that are covered by the operating instructions as an improper adjustment of other controls may result in damage and will often require extensive work by a qualified technician to restore the product to its normal operation.
- e) If the product has been dropped or damaged in any way.
- f) When the product exhibits a distinct change in performance-this indicates a need for service.

23. Servicing

Do not attempt to service this product yourself as opening or removing covers may expose you to dangerous voltage or other hazards. Refer all servicing to qualified service personnel.

24. Replacement parts

When replacement parts are required, be sure the service technician has used replacement parts specified by the manufacturer or have the same characteristics as the original part. Unauthorized substitutions may result in fire, electric shock, or other hazards.

25. Safety Check

Upon completion of any service or repairs to this product, ask the service technician to perform safety checks to determine that the product is in proper operating condition.

Precautions

Notes on handling

- ❑ When shipping the DVD player, always use the original shipping carton and packing materials. For maximum protection, repack the unit as it was originally packed at the factory.
- ❑ Do not use volatile liquids, such as insect spray, near the DVD player. Do not leave rubber or plastic products in contact with the DVD player for a long time. They will leave marks on the finish.
- ❑ The top and rear panels of the DVD player may become warm after a long period of use. This is normal and not a malfunction.
- ❑ When the DVD player is not in use, be sure to remove the disc and turn off the power.
- ❑ If you do not use the DVD player for a long period, the unit may not function properly in the future. Turn on and use the DVD player occasionally.

Notes on Locating

- ❑ When you place this DVD player near a TV, radio, or VCR, the playback picture may become poor and the sound may be distorted. In this case, move the DVD player away from the TV, radio, or VCR.

Notes on Cleaning

Use a soft, dry cloth for cleaning.

- ❑ For stubborn dirt, soak the cloth in a weak detergent solution, wring well and wipe. Use a dry cloth to wipe it dry. Do not use any type of solvent, such as thinner and benzine, as they may damage the surface of the DVD player.
- ❑ If you use a chemical saturated cloth to clean the unit, follow that product's instructions.

Warning: Cleaning and adjustment of lenses and/or other components of playback mechanism should be performed by a qualified service technician.

To Obtain a Clear Picture

The DVD player is a high technology, precision device. If the optical pick-up lens and disc drive parts are dirty or worn down, the picture quality becomes poor. To obtain a clear picture, we recommend regular inspection and maintenance (cleaning or parts replacement) every 1,000 hours of use depending on the operating environment. For details, contact your nearest dealer.

Notes on Moisture Condensation

Moisture condensation damages the DVD player. Please read the following carefully.

Moisture condensation occurs, for example, when you pour a cold drink into a glass on a warm day. Drops of water form on the outside of the glass. In the same way, moisture may condense on the optical pick-up lens inside this unit, one of the most crucial internal parts of the DVD player.

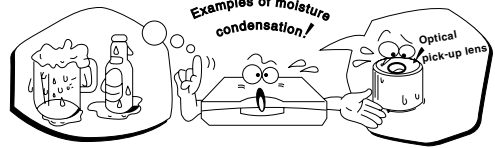

Moisture condensation occurs during the following cases.

- ❑ When you bring the DVD player directly from a cold place to a warm place.
- ❑ When you use the DVD player in a room where you just turned on the heater, or a place where the cold air from the air conditioner directly hits the unit.
- ❑ In summer, when you use the DVD player in a hot and humid place just after you move the unit from an air conditioned room.
- ❑ When you use the DVD player in a humid place.

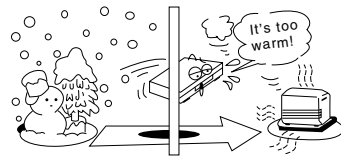

- ❑ **Do not use the DVD player when moisture condensation may occur.**

If you use the DVD player in such a situation, it may damage discs and internal parts. Remove the disc, connect the power cord of the DVD player to the wall outlet, turn on the DVD player and leave it "ON" for two or three hours. After two or three hours, the DVD player will have warmed up and evaporated any moisture. Keep the DVD player connected to the wall outlet and moisture condensation will seldom occur.

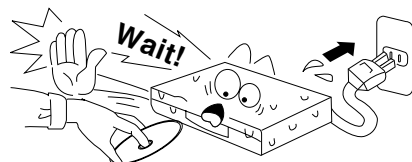

Notes on Discs

This section shows you how to handle, clean, and store discs.

On Handling Discs

- Do not touch the playback side of the disc.

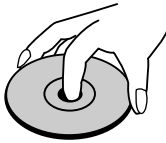

- Do not attach paper or tape to discs.



On Storing Discs

- Do not store discs in a place subject to direct sunlight or near heat sources.
- Do not store discs in places subject to moisture and dust such as a bathroom or near a humidifier.
- Store discs vertically in a case. Stacking or placing objects on discs outside of their case may cause warping.

On Cleaning Discs

- Fingerprints and dust on the disc cause picture and sound deterioration. Wipe the disc from the center outward with a soft cloth. Always keep the disc clean.
- If you cannot wipe off the dust with a soft cloth, wipe the disc lightly with a slightly moistened soft cloth and finish with a dry cloth.
- Do not use any type of solvents such as thinner, benzene, commercially available cleaners or anti-static spray for vinyl LPs. They may damage the disc.

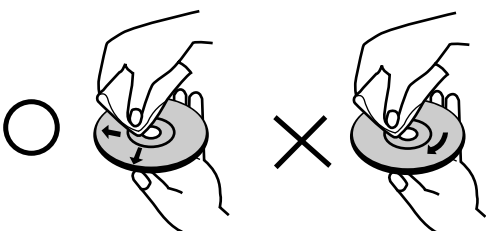

About This Owner's Manual

- This owner's manual explains the basic instructions of this DVD player.
- Some DVD video discs have functions that may not be explained in this owner's manual. Therefore, some instructions may differ from this owner's manual, and there may be extra instructions. In this case, follow the instructions displayed on the TV screen or package.
- “” may appear on the TV screen during operation. This icon means the function explained in this owner's manual is not available on that specific DVD video disc.

Identification of Controls

Front Panel

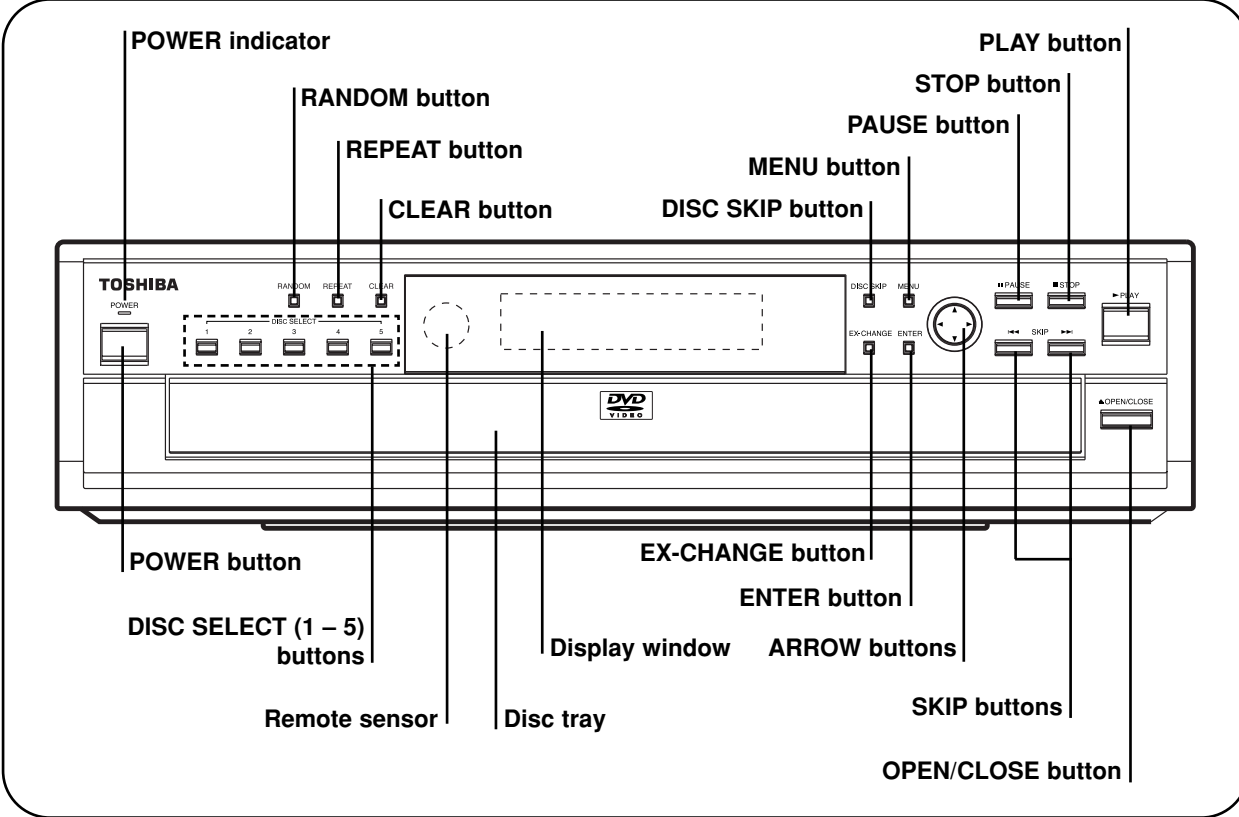

Display Window

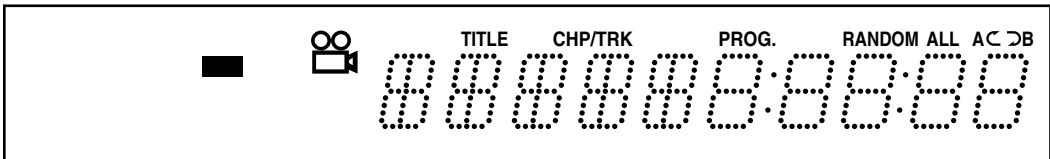

Identification of Controls (Cont'd)

Rear Panel

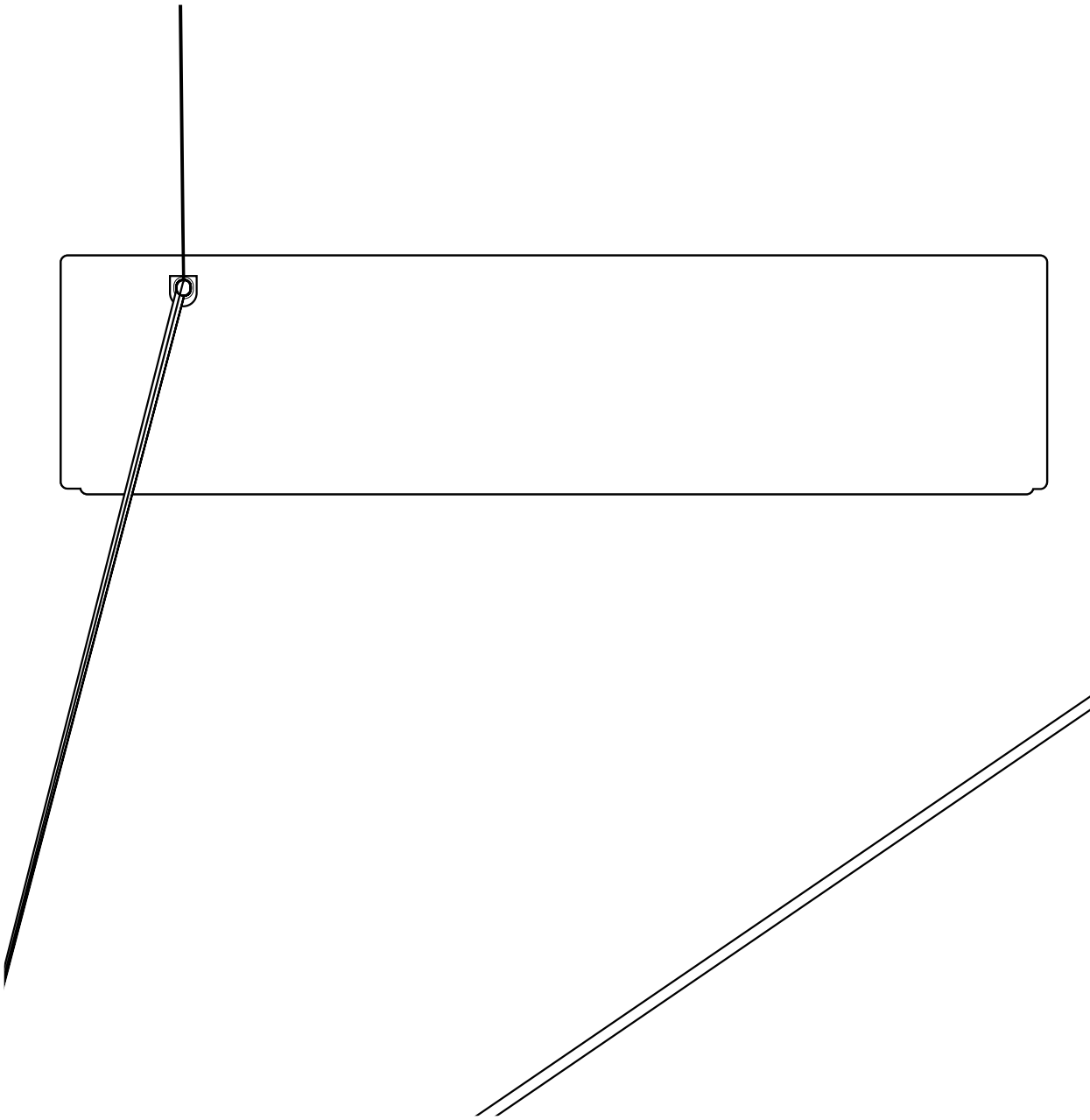

Identification of Controls (Cont'd)

Remote Control

You will find instructions for each of the remote control functions in the appropriate sections of this instruction manual.

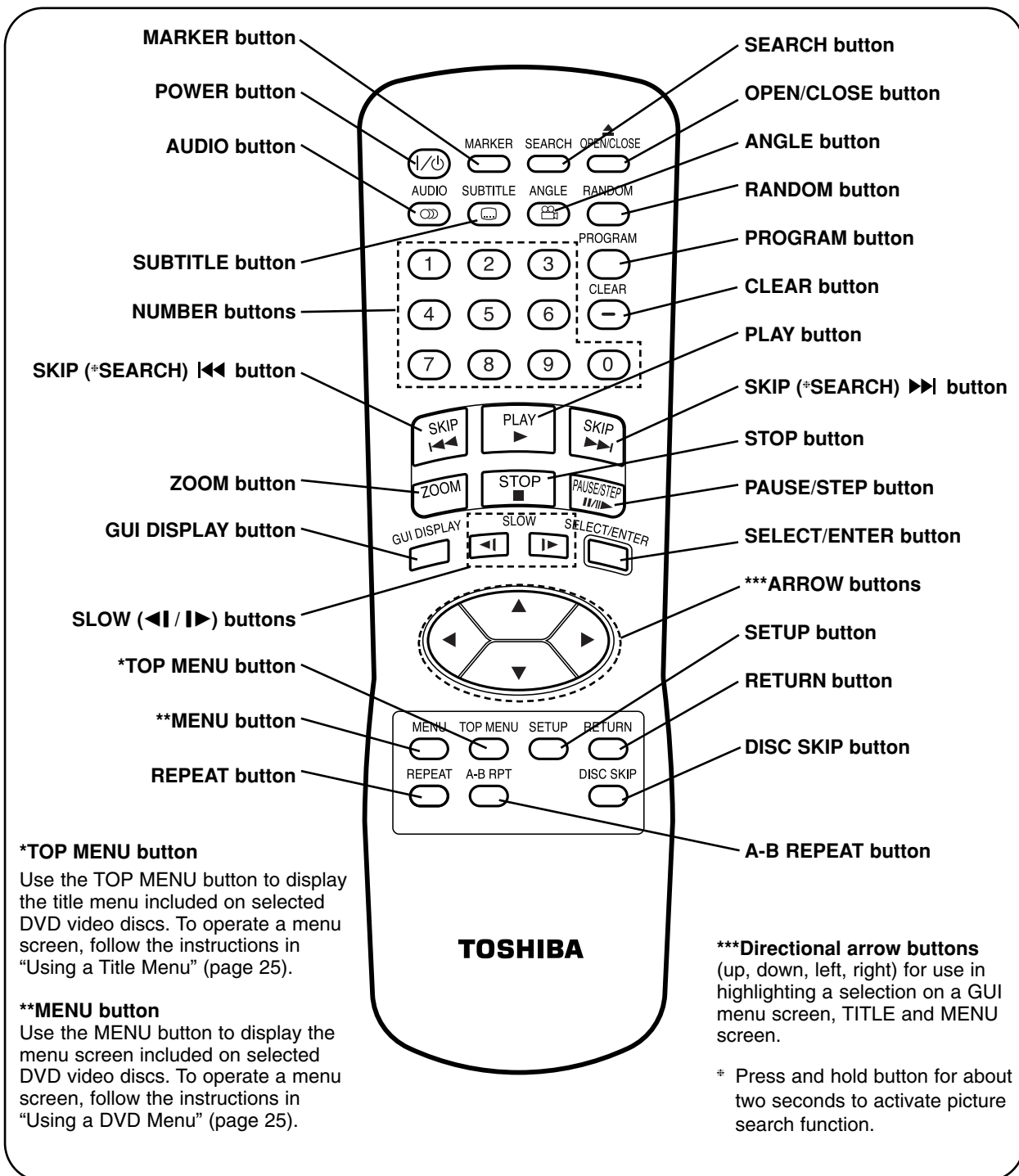

***TOP MENU button**

Use the TOP MENU button to display the title menu included on selected DVD video discs. To operate a menu screen, follow the instructions in "Using a Title Menu" (page 25).

****MENU button**

Use the MENU button to display the menu screen included on selected DVD video discs. To operate a menu screen, follow the instructions in "Using a DVD Menu" (page 25).

*****Directional arrow buttons** (up, down, left, right) for use in highlighting a selection on a GUI menu screen, TITLE and MENU screen.

* Press and hold button for about two seconds to activate picture search function.

Identification of Controls (Cont'd)

Preparing the Remote Control

Insert the batteries into the remote control so you can use it to operate the DVD player.

1 Open the battery cover.

2 Insert batteries (AAA size).

- Make sure to match the + and - on the batteries to the marks inside the battery compartment.

3 Close the cover.

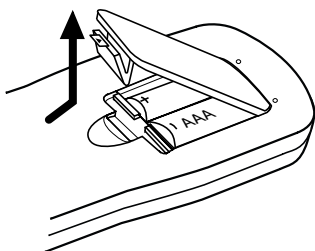

Notes on batteries

- Improper use of batteries may cause battery leakage and corrosion.
- To operate the remote control correctly, follow the instructions.
- Do not insert the batteries into the remote control in the wrong direction.
- Do not charge, heat, open, or short-circuit the batteries. Do not throw the batteries into fire.
- Do not leave dead or exhausted batteries in the remote control.
- Do not use different types of batteries together, or mix old and new batteries.
- If you do not use the remote control for a long period of time, remove the batteries to avoid possible damage from battery corrosion.
- If the remote control does not function correctly or if the operating range becomes reduced, replace all batteries with new ones.
- If battery leakage occurs, wipe the battery liquid from the battery compartment, then insert new batteries.
- The batteries should last about one year with normal use.

Operating with the Remote Control

This section shows you how to use the remote control.

Point the remote control at the remote sensor and press the buttons.

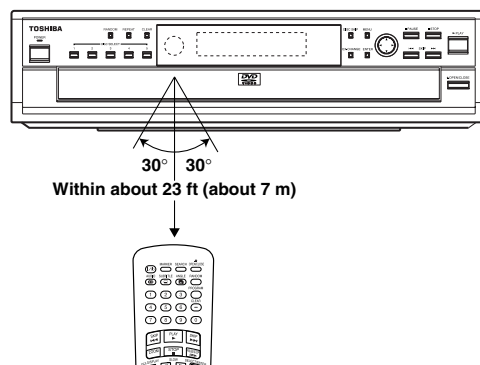

Distance: About 23 ft (7 m) from the front of the remote sensor

Angle: About 30° in each direction of the front of the remote sensor

- * Do not expose the remote sensor of the DVD player to a strong light source such as direct sunlight or illumination. If you do so, you may not be able to operate the DVD player with the remote control.

Notes on the remote control

- Point the remote control at the remote sensor on the DVD player.
- Do not drop or give the remote control a shock.
- Do not leave the remote control in an extremely hot or humid place.
- Do not spill water or put anything wet on the remote control.
- Do not disassemble the remote control.

Connecting to a TV

Connect the DVD player to your TV.

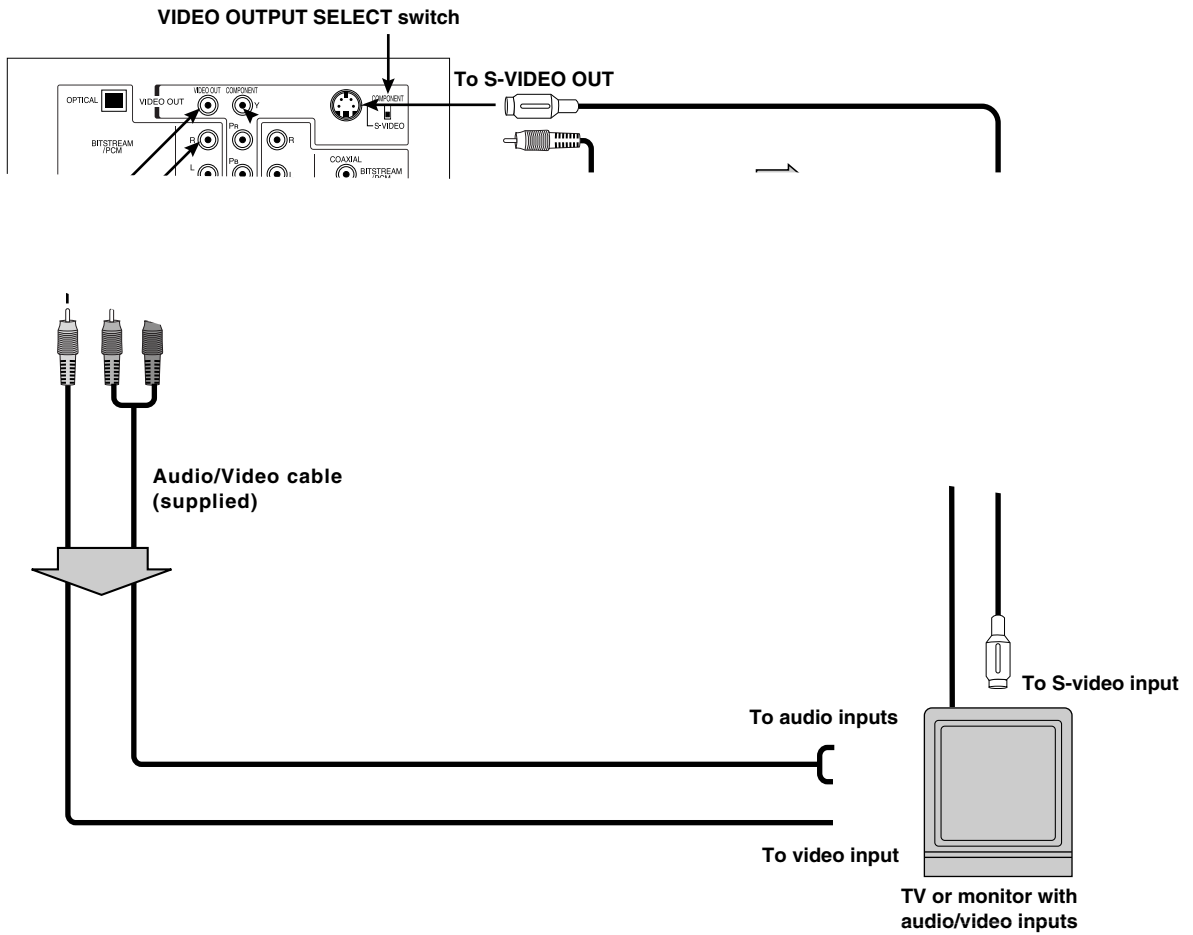

Connecting to an Audio System

You can listen to the sound of audio CDs and DVD video discs in stereo.

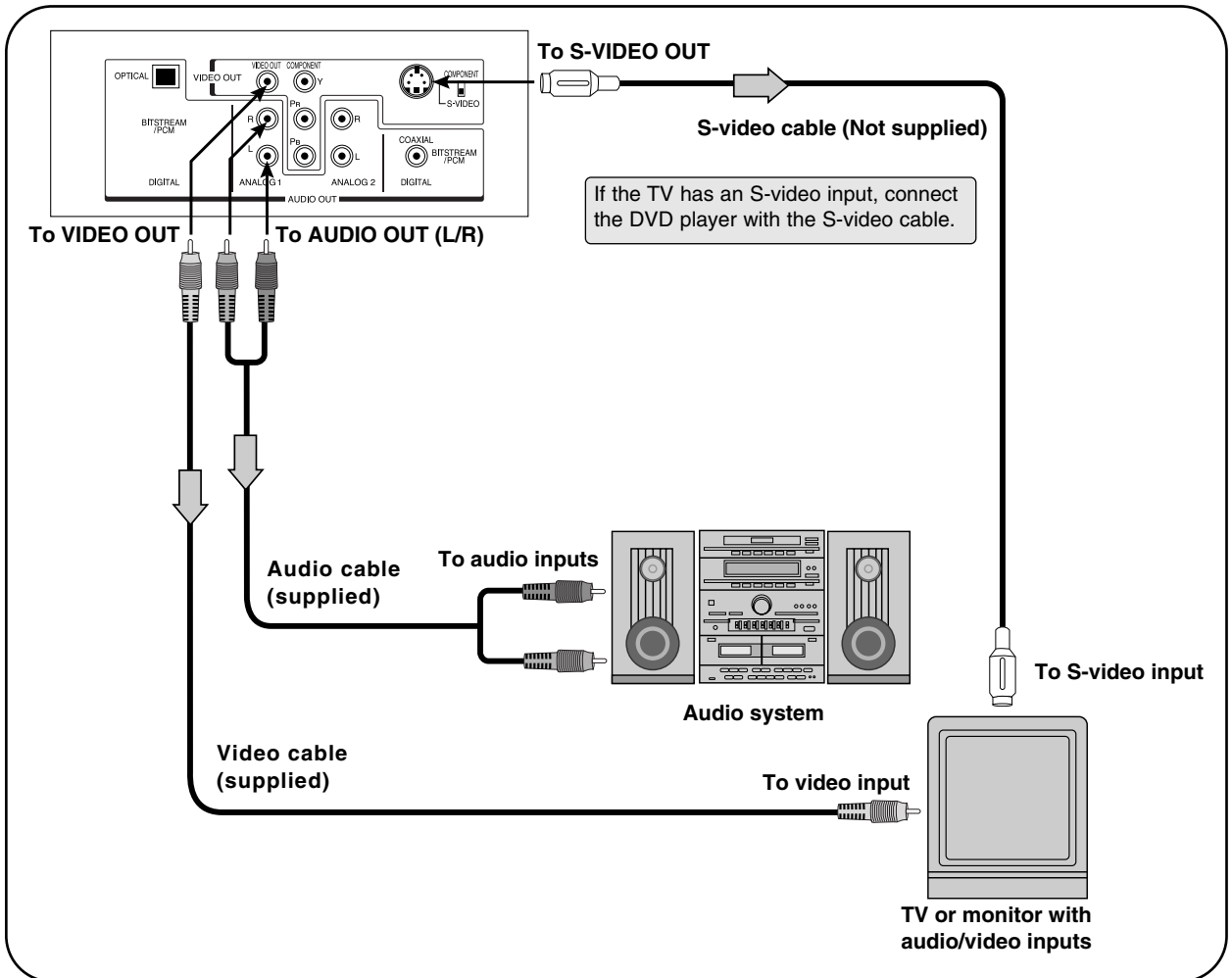

Notes

- Refer to the owner's manual of your audio system as well.
- Before you connect the DVD player to other equipment, be sure to turn off the power and unplug all of the equipment from the wall outlet before making any connections.
- If you place the DVD player near a tuner or radio, the radio broadcast sound might be distorted. In this case, move the DVD player away from the tuner and radio.
- The output sound of the DVD player has a wide dynamic range. Be sure to adjust the receiver's volume to a moderate listening level. Otherwise, the speakers may be damaged by a sudden high volume sound.
- Turn off the receiver before you connect or disconnect the DVD player's power cord. If you leave the receiver power on, the speakers may be damaged.

Warning

Do not set the Digital Audio Output of this DVD player to "Dolby Digital" unless you are connecting the DIGITAL OUT jack of this DVD player to an AV decoder that has the Dolby Digital decoding function. High volume sound may damage your hearing as well as the speakers (Refer to "Selecting Digital Audio Output" on page 38).

Connecting to Optional Audio System

Enjoying Dolby Digital Sound

You can enjoy the high quality dynamic sound of Dolby Digital, Dolby Pro Logic, and 2 Channel Digital Stereo.

Dolby Digital

Dolby Digital is the surround sound technology used in theatres showing the latest movies, and is now available to reproduce this realistic effect in the home. You can enjoy motion picture and live concert DVD video discs with this dynamic realistic sound by connecting the DVD player to a 6 channel receiver equipped with a Dolby Digital decoder or Dolby Digital processor.

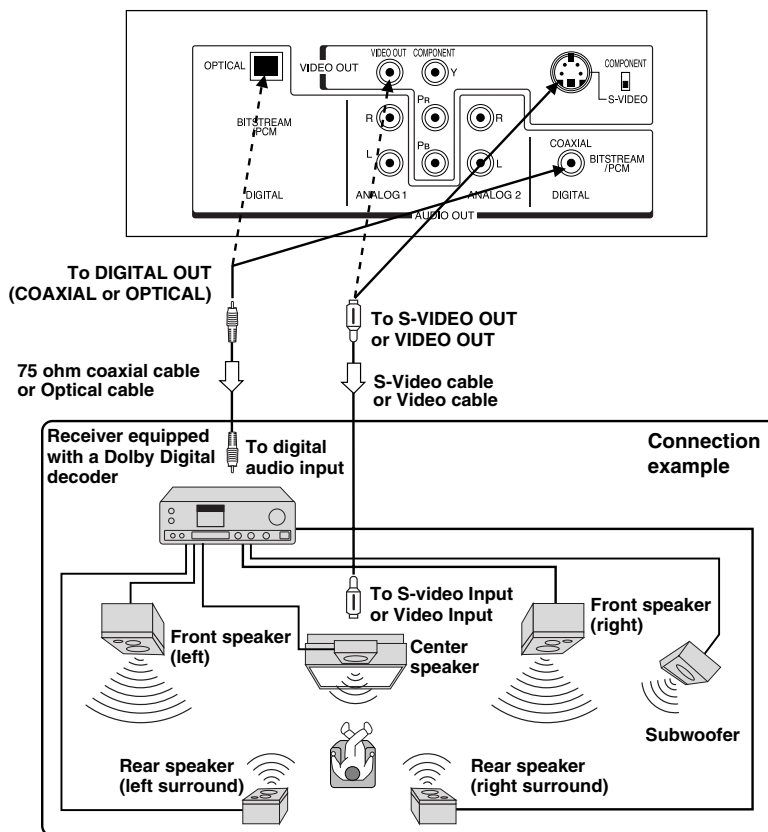

To enjoy Dolby Digital sound from this DVD player you need the following:

- DVD recorded in Dolby Digital
- 6 channel receiver equipped with a Dolby Digital decoder, or Dolby Digital processor and power receiver
- 5 speakers and 1 sub woofer

To enjoy Dolby Digital sound
You need to select "Dolby Digital" from the SETUP menu.

* Manufactured under license from Dolby Laboratories. "Dolby", "Pro Logic", and the double-D symbol are trademarks of Dolby Laboratories. Confidential Unpublished works. Copyright 1992-1997 Dolby Laboratories. All rights reserved.

Notes

- Refer to the owner's manual of your audio equipment as well.
- Before you connect the DVD player to other equipment, be sure to turn off the power and unplug all of the equipment from the wall outlet before making any connections.
- The output sound of the DVD player has a wide dynamic range. Be sure to adjust the receiver's volume to a moderate listening level. Otherwise, the speakers may be damaged by a sudden high volume sound.
- Turn off the receiver before you connect or disconnect the DVD player's power cord. If you leave the receiver power on, the speakers may be damaged.

Connecting to Optional Audio System (Cont'd)

Enjoying Dolby Pro Logic Surround Sound

Dolby Pro Logic Surround

You can still enjoy the excitement of Surround Sound even if your A/V receiver does not offer Dolby Digital decoding. If your A/V receiver has a Dolby Pro Logic decoder, refer to the following connection diagram.

Connect one or two rear speakers. The output sound from the rear speakers will be monaural even if you connect two rear speakers.

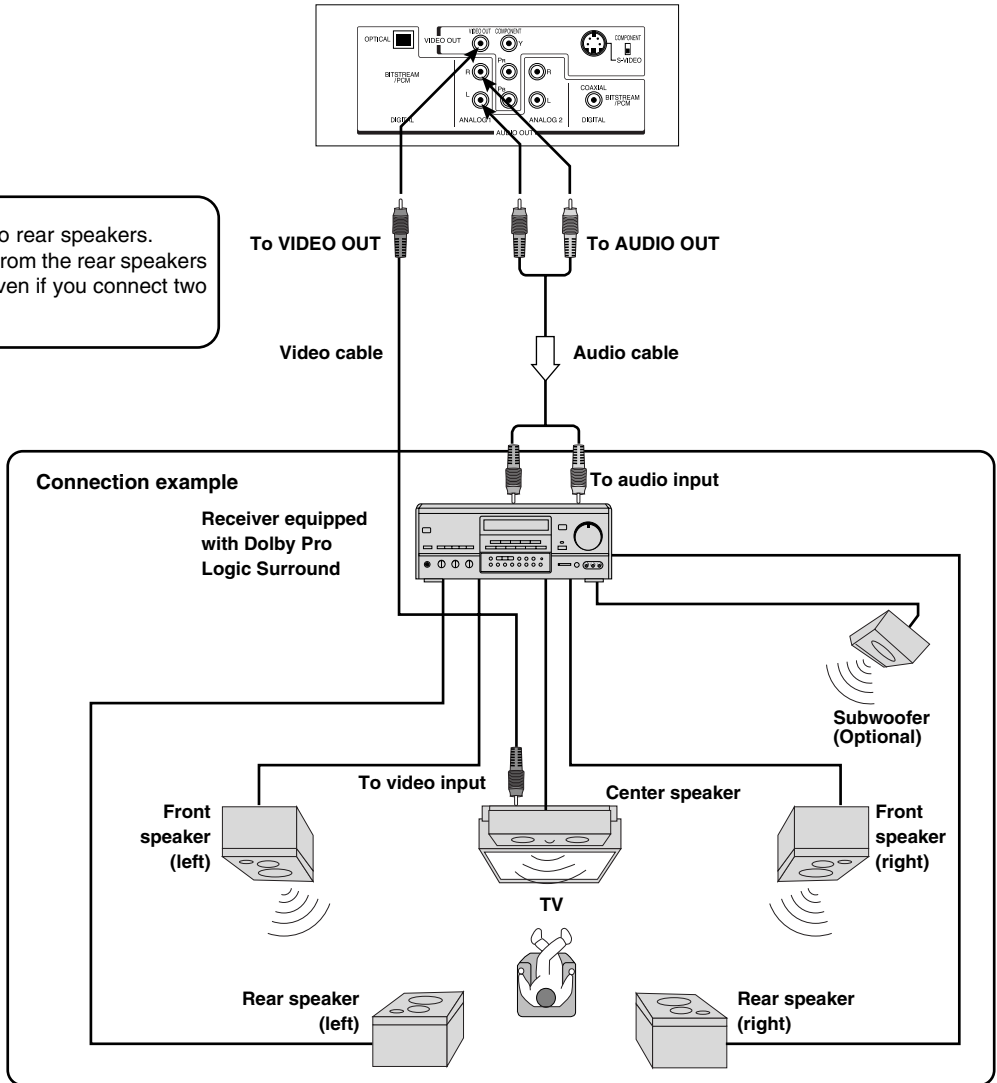

- **With a receiver equipped with Dolby Digital**
Connect the equipment the same way as described in “Enjoying Dolby Digital Sound” on the previous page. Refer to the receiver’s owner’s manual and set the receiver so you can enjoy Dolby Pro Logic Surround sound.

Warning

Do not set the Digital Audio Output of this DVD player to “Dolby Digital” unless you are connecting the DIGITAL OUT jack of this DVD player to an AV decoder that has the Dolby Digital decoding function. High volume sound may damage your hearing as well as the speakers (Refer to “Selecting Digital Audio Output” on page 38).

Connecting to Optional Audio System (Cont'd)

Enjoying 2 Channel Digital Stereo Sound

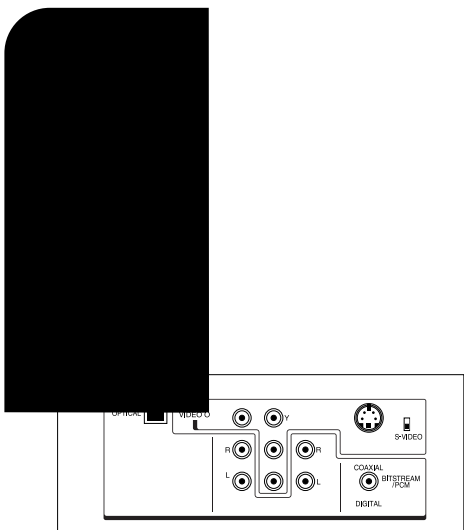

Enjoying DTS Sound

Basic Playback



This section explains the basics on how to play back a DVD video disc.

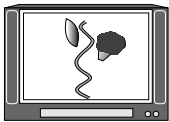

Preparations

- When you want to play back DVD video discs, turn on the TV and select the video input source connected to the DVD player.
- When you want to enjoy the sound of DVD video discs or audio CDs from the audio system, turn on the audio system and select the input source connected to the DVD player.
- For connection details, see pages 12 through 16.
- Set the playback picture size according to the aspect ratio of the connected TV via the SETUP menu (TV Aspect).
- If you do not have the necessary equipment to enjoy Dolby Digital sound, set the Digital Audio Output (via the SETUP menu) to "PCM".

1 Press POWER.

The DVD player turns on and the power indicator lights.

2 Press OPEN/CLOSE.

The disc tray opens.

- You can open the disc tray by pressing this button even if the DVD player is in standby mode.

3 Place a disc on the disc tray with the playback side down.

- There are two different disc sizes. Place the disc in the correct guide on the disc tray. If the disc is out of the guide, it may damage the disc and cause the DVD player to malfunction.
- Do not place anything except 3" discs or 5" discs on the disc tray.
- Discs can be loaded one at a time by pressing DISC SKIP or DISC SELECT (1 - 5) to rotate the carousel.

4 Press OPEN/CLOSE or PLAY to close the loading drawer.

The disc on the tray 1 is ready to be played back. Playback may begin automatically depending on the disc.

If no disc is loaded on the disc tray 1, select another disc by following step 5.

- Do not close the loading drawer by hand.
- If the disc is placed in upside down (and it is a single sided disc), "NO DISC" or "DISC ERROR" appears on the TV screen.

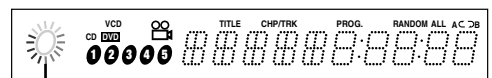

Operating status indicator

- If you insert an audio CD, the CD indicator lights up on the display. The title number does not appear.
- After playing back all of the chapters in the title, the DVD player automatically stops and returns to the menu screen.

Basic Playback (Cont'd)

- 5** If you want to select another disc, press **DISC SKIP** on the remote control once or more, or press **DISC SELECT (1 - 5)** on the front panel.

Also you can select a disc in the DVD player directly by using the remote control, press **DISC SKIP** and then press a number button (1-5) on the remote control within one second.

- 6** Press **PLAY** to begin playback.

Playback begins.

You can skip this step if the disc is already playing automatically.

The menu screen appears on the TV screen.

In the case of interactive DVDs with playback, a menu screen appears on the TV screen. Perform the following steps:

- 7** Press **▲/▼/◀/▶** and press **SELECT/ENTER**, or press the numeric button(s), to select the desired item.

Playback of the selected item begins.

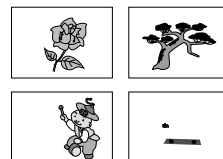

- For further information, refer to the disc jacket of the disc you are playing.

After operation

When the unit is not in use, remove the disc and press **POWER** to turn off the power.

Notes

- Do not move the DVD player during playback. Doing so may damage the disc and the DVD player.
- Use the **OPEN/CLOSE** button on the remote control or DVD player to open and close the disc tray. Do not push the disc tray while it is moving. Doing so may cause the DVD player to malfunction.
- Do not push up the disc tray or put any objects other than discs on the disc tray. Doing so may cause the DVD video player to malfunction.
- Keep your fingers well clear of the disc tray as it is closing. Be especially careful with children's fingers around the closing disc tray as there is a risk of personal injury.
- When "⊘" appears on the TV screen while a button is pressed, it means that this function is not available on the disc you are playing.
- Depending on the DVD disc, some operations may be different or restricted. Refer to the jacket or case of the disc you are playing.

Basic Playback (Cont'd)

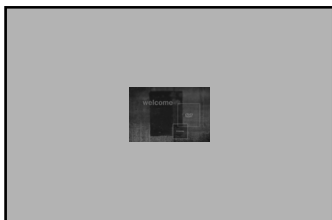
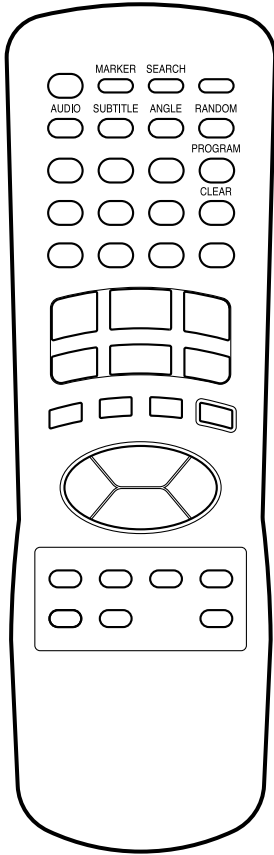

Screen Saver

Stopping Play

Press **STOP** during playback.

Resume Play

- When play is stopped, the unit memorizes the point where **STOP** was pressed (**RESUME** function). Press **PLAY** and playback will resume from this point.

Notes

- This operation works only with discs for which the elapsed playing time appears in the DVD display window during stop.
- Resume function will be cleared when the **STOP** is pressed on the **STOP** mode.
- Resume function will be cleared when the power is turned off and then on.
- Opening the disc tray cancels Resume function.
- The Resume function may not be available on some DVD discs or Video CDs (version 2.0).

Last Scene Memory

This player memorizes last scene for the last disc you have watched. Settings remain in memory even if you remove the disc from the player or switch off the player. If you load a disc that has its settings memorized, Latest Stop Position is automatically recalled.

Notes

- Settings are stored in memory for use any time.
- Switching of the audio mode, etc., is automatic on some discs.
- This player does not memorize if you switch off the player when a DVD or title menu appears on the TV screen.

Screen Saver

The screen saver is useful to prevent your display from becoming damaged.

The screen saver picture appears when you leave the DVD player in stop mode for about 5 minutes.

Automatic power off function

After the Screen Saver has been engaged for about 5 minutes, the DVD player will automatically turn itself off.

Basic Playback (Cont'd)

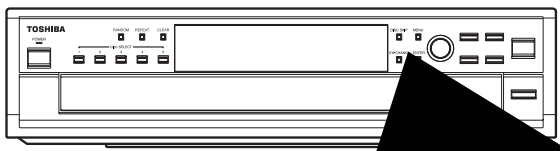

Exchanging Discs during Playback

- 1** Press **EX-CHANGE** during playback to open the loading drawer.
- 2** Press **DISC SKIP** to rotate the disc tray to the desired position.
The carousel will advance clockwise by one disc tray.
Note: The disc tray which was in the play position can not be exchanged.
- 3** Exchange the discs and press **EX-CHANGE** or **OPEN/CLOSE** to close the loading drawer.

Skipping Discs

Press **DISC SKIP** during playback or in the stop mode.

- Each time the button is pressed, the next disc tray is selected.

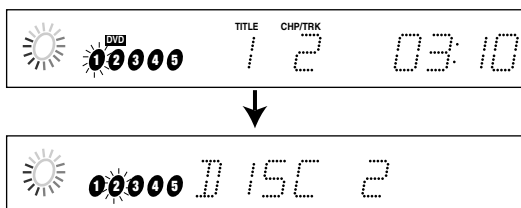

Notes

- When the **DISC SKIP** is pressed during playback or in the stop mode, the disc tray advances and playback begins from the beginning of the next disc.
- If there is no disc on the selected disc tray, the disc tray of the next number will be selected.
- When **DISC SKIP** is pressed during playback of disc 5, playback of disc 1 will start.

Exchanging the Disc and Starting Playback

- 1** Press **OPEN/CLOSE** during playback or in the stop mode.
Play is stopped (if pressed during playback), the loading drawer opens and the disc tray which was in the play position comes to the center position.
- 2** Exchange the disc in the center position.

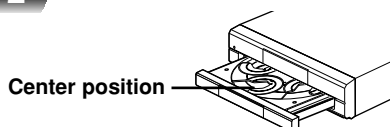

- 3** Press **OPEN/CLOSE** or **PLAY** again.
The loading drawer closes, the disc tray returns to the play position and playback begins from the new disc.

Still Picture (Pause)

Press PAUSE/STEP during playback.

- DVD/Video CD
The player will be placed in the still picture mode.
- CD
Playback will be paused.

Frame Advance (DVD and Video CD only)

Press PAUSE/STEP during still playback.

(Each time you press PAUSE/STEP, the picture advances one frame)

To resume normal playback, press PLAY.

Skipping Chapters and Tracks Forward or Back

Skipping forward

Press SKIP ►► during playback.

A chapter (DVD) or a track (CD/Video CD) is skipped each time this button is pressed.

Skipping back

Press SKIP ◄◄ during playback.

- When this button is pressed once midway through a chapter/track, the player returns to the start of that chapter/track. When it is pressed repeatedly, a chapter/track is skipped each time the button is pressed.

For your reference:

- When ◄◄ SKIP ►► is pressed during menu play of video CDs equipped with PBC (Version 2.0), a menu screen may appear.
-

Special Playback (Cont'd)



You can play back discs at various speeds.

To Scan at Fast Forward or Fast Reverse Playback.

Press and hold **SKIP** **◀◀** or **▶▶** button for about two seconds during playback.

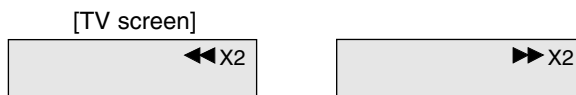

- The image advances (or reverses) is relatively slow at first. When the button is pressed again, the speed increases. (Each time the button is pressed, the speed increases up to 4 steps (DVD) or 3 steps (CD/Video CD).)
- The speed will be maintained even after the button is released.

To return to normal playback, press **PLAY**.

Note

- The DVD player does not play back sound during high speed reverse and forward playback of DVD video discs. However, the DVD player plays back sound during fast forward or fast reverse playback of audio CDs.
- Subtitles do not appear on the screen during scan playback.

Playing in Slow-Motion (DVD and Video CD only)

Press **SLOW** **◀|** or **|▶** during playback.

The playback speed is reduced to 1/16 of the normal speed.

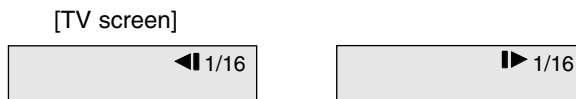

- The speed that the image advances (or reverses) is slow at first. When the button is pressed again, the speed increases. (Each time the button is pressed, the speed increase up to 4 steps.)
- The speed will be maintained even after the button is released.

To return to normal playback, press **PLAY**.

Notes

- The sound is muted during slow-motion playback.
- The Slow-Motion playback in reverse is not applicable for Video CDs.
- The SLOW buttons do not function with Audio CDs.

General Information about GUI Menu

This unit features an icon based GUI menu showing disc information (title/chapter/track number, elapsed playing time, audio/subtitle language, angle, and sound) and player information (repeat play, play mode, marker, etc.). Some icons only show the indicated information. Other icons allow settings to be changed.

Common procedures

Press GUI DISPLAY during playback.

- Title function can be accessed from the stop mode.

2 Press ▲/▼ to select the desired item.

- The current selected item is highlighted by a yellow frame around its menu icon.

3 Press ◀▶ to select the desired setting.

- When numbers are displayed (e.g. title number), the numeric buttons can also be used for setting instead of ◀▶.
- For some functions, the setting will be registered immediately; for others, SELECT/ENTER must be pressed.

To clear the GUI Menu display, press GUI DISPLAY again.

Detailed Description of each GUI Menu Icon

You can view information about a disc and its operational status on the TV screen.



Indicates the current title number;
and to jump to a desired title number

Indicates the current chapter number;
and to jump to a desired chapter number

Indicates the elapsed time;
and directly select scenes by the desired time.

Indicates the current audio soundtrack language,
encoding method, channel number;
and to change the settings.

Indicates the current subtitles language;
and to change the setting.

Indicates the current angle number;
and to change the angle.

Indicates the current sound enhancement (NORMAL or
3D SURROUND);
and to change the setting.

Indicates the current track number;
and to jump to the desired track number

Indicates the elapsed time;
(Display only)

Indicates the current audio (STEREO, LEFT, RIGHT);
and to select a desired audio channel.

Indicates the current sound enhancement (NORMAL or
3D SURROUND);
and to change the setting (Audio CD only).

Using a Title Menu

Press TOP MENU.

A list of the titles on the disc is displayed.

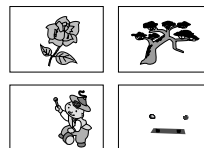

Pressing TOP MENU again to resume play from the location when TOP MENU was first pressed.

- Resume play may not be possible on certain discs.

Press **▲/▼/◀/▶** and press **SELECT/ENTER** or **PLAY**, or press the numeric button(s), to select a desired title.

The selected title now begins playback.

Press MENU during playback.

The DVD menu encoded on the disc is displayed.

Pressing MENU again resumes playback from the scene when MENU was first pressed.

- Resume playback may not be possible on certain discs.

Press **▲/▼/◀/▶** and press **SELECT/ENTER**, or press the numeric button(s), to select a desired item.

The selected item is now displayed.



Changing Subtitle Language

It is possible to change the subtitle language to a different language from the one selected at the initial setup. (See page 33 for further info.)

This operation functions only on discs that include multiple subtitle languages.

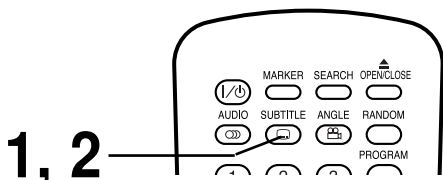

- 1 Press SUBTITLE during playback.**
When no subtitles are available, "OFF" will be displayed instead of the language number.



- 2 Press SUBTITLE repeatedly until the desired language is selected.**
The number corresponding to the subtitle language being played back is displayed.



Notes

- In some cases, the subtitle language is not changed to the selected one immediately.
- When a disc supporting closed captioned data is played, the subtitle and the closed caption data may overlap each other on the TV screen. In this case, turn the subtitle off.
- When a desired language can not be selected even after pressing the button several times, the language is not available on the disc.
- When the power is turned on or the disc is removed, subtitles will appear in the language selected at the initial setting. If this language is not recorded on the disc, the disc's priority language appears.

To eliminate the On Screen Subtitles.
Press SUBTITLE repeatedly to select OFF at step 2.

Changing Audio Soundtrack Language



It is possible to change the audio soundtrack language (or encoding method, channel number) to a different language from the one selected at the initial setup. (See page 33 for further info.) This operation works only with discs on which multiple audio soundtrack languages are included.

It may be possible to change the audio channel in case of audio CD.

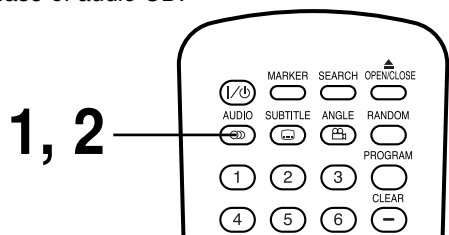

- DVD
- 1 Press AUDIO during play.**
Number of the audio soundtrack language being played back.



- 2 Press AUDIO repeatedly until the desired language (or encoding method, channel number) is selected.**



- CD/Video CD
- 1 Press AUDIO during playback.**



- 2 Press AUDIO repeatedly until the desired sound is selected.**



Notes

- When the desired language is not selected even after pressing the AUDIO button several times, the language is not available on the disc.
- When the power is turned on or the disc is removed, the language heard is the one selected at the initial setup. If this language is not mastered on the disc, only the language available on the disc will be heard.
- Some discs may not respond to Audio feature.

Viewing Multi Angle Discs



Some DVDs may contain scenes which have been shot simultaneously from a variety of different angles. You can view each of these different angles using the ANGLE button. (The recorded angles differ depending on the disc used.)

1 Press ANGLE during playback.

Number of angle being played back is displayed.



2 Press ANGLE repeatedly until the desired angle is selected.



For your reference

- The ANGLE indicator will blink in the DVD display window during scenes recorded at different angles as an indication that angle switching is possible.
- The angle number can be programmed beforehand; the angle will switch to the selected number when the ANGLE indicator blinks.

Note

This unit can produce a 3D Surround effect, using 3D Surround Sound technology, which simulates multi-channel audio playback from two conventional stereo speakers instead of the five or more speakers normally required to listen to multi-channel audio from a home theatre. This feature works with DVD discs encoded with Dolby Pro Logic and Dolby Digital audio tracks.

1 Press GUI DISPLAY during playback.

2 Press ▲/▼ to select SOUND item.



3 Press ◀/▶ repeatedly until the desired sound is selected.

Each time this button is pressed, the icon display changes.



Notes

- This 3D Surround effect may not be available on some DVD discs, including those recorded with a mono audio soundtrack.
- Turn off the TV surround sound and other surround effects when using this 3D surround effect.
- For best 3D Surround effect using only two speakers it is recommended that the two speakers be positioned approximately 8' to 10' apart, and the listening position should be 8' to 10' away from the speakers.



Repeat Play

Repeating viewing (listening)

Press REPEAT during playback.

Each time this button is pressed, the icon display changes as shown below and the disc will repeat a chapter or title (DVD) or a track (CD/Video CD).

• DVD

- Repeat of chapter being played
- Repeat of title being played
- Cancels repeat mode (normal play)

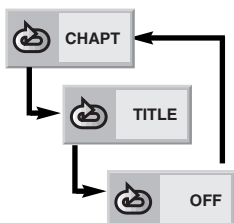

• CD/Video CD

- Repeat of track being played
- Repeat of entire current disc contents
- Repeat of entire all disc contents
- Cancels repeat mode (normal play)

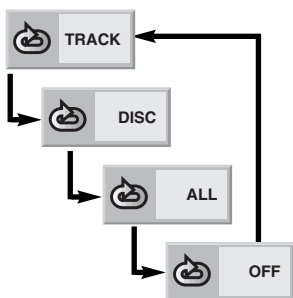

To enjoy program repeat play (CD/Video CD)

If REPEAT is pressed during program play, repeat play is operated as below.

- Repeat of the current programmed track
- Repeat of all programs
- Cancel repeat mode (Program play)

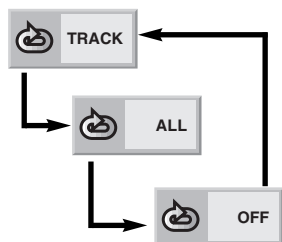

To return to normal play

Press REPEAT several times until "OFF" is displayed.

Repeating sections between two specific points (A-B repeat)

1 While the disc is playing, press A-B RPT at the point where repeat play is to start (A).



- You can select "OFF" at this step by pressing CLEAR.

2 Press A-B RPT during playback at the point where repeat play is to be concluded (B).



Repeat play of the selection between points A and B starts.

To return to normal play

Press A-B RPT once "OFF" is displayed.



Notes

- Repeat play works only with discs for which the elapsed playing time appears in the DVD display window during playback.
- Repeat play may not work correctly with some DVDs and some Video CDs.
- A-B repeat play works only within a DVD title or a CD/Video CD track .
- Some subtitles proceeding point A or B may not be displayed.

Storing Markers in Memory to be Viewed or Listened to again

Storing a MARKER in the DVD memory is similar to marking your page in a book. It allows you to quickly return to any point on the disc.

Storing a marker in the memory

- 1 Press **MARKER** during play at the starting point to be viewed (listened to) again.



Indicates "1/9" is stored in the memory.
Up to 9 marks can be stored in the memory.

Recalling/Clearing a marker

- 2 Press **SEARCH** during playback.
The MARKER SEARCH menu will appear on the TV screen.



- 3 Press **◀▶** to select the marker to be recalled/cleared.

Press **SELECT/ENTER** to recall a marker.
Or press **CLEAR** to clear a marker.

Playback resumes from the point corresponding to the selected marker.

Notes

- These operations work only with discs for which the elapsed playing time appears in the DVD display window during playback or stop operation.
- Some subtitles recorded around the marker may not be displayed (DVD).
- All the markers are cleared when the power is turned off or the disc is removed.
- The marker cannot be memorized when the DVD or title menu is displayed on the TV screen.

Zoom Feature

Random Play

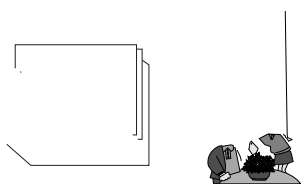

Program Play



The player plays the tracks on the disc in the order you specify.

Note: Program play function is possible only with audio CDs. It does not work with DVD movie discs and Video CDs (Version 2.0).

1 Press PROGRAM on the stop mode.

The program menu screen appears on the TV.

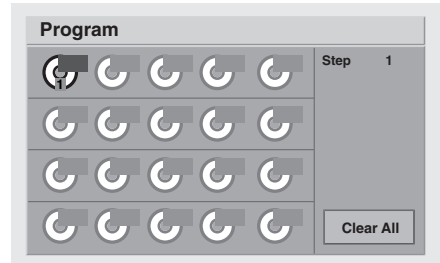

- To exit the screen, press PROGRAM or RETURN.

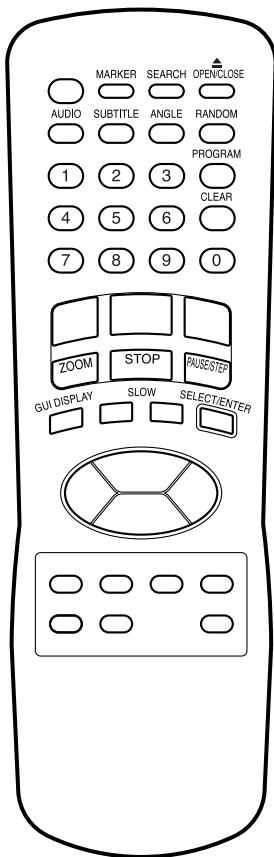

2 Enter the disk number using the numerical keys (1-5) and then press SELECT/ENTER.

3 Enter the track number using the numerical keys (0-9) and then press SELECT/ENTER.

The next area is selected.

4 Repeat steps 2 to 3.

Up to 20 tracks can be programmed.

5 Press PLAY to exit the menu.

The selected tracks are stored in the player memory and playback begins with the first programmed sequence.

After playback of all programmed tracks is completed, playback is stopped

Clearing the program

• To clear the programmed tracks one by one

Press ▲/▼/◀/▶ to select the unwanted track and then press CLEAR.

• To clear all the programmed tracks

Press ▲/▼/◀/▶ to select "Clear All" and then press SELECT/ENTER. Press PROGRAM or RETURN to exit the screen. (The programs are also cleared when the power is turned off or the disc is removed.)



Selection of Initial Settings

Once the initial settings have been completed, the player can always be operated under the same conditions (especially with DVD discs). The settings will be retained in the memory until they are changed, even if the power is switched off.

Selection of initial settings

- 1 Press SETUP in the stop or playback mode.**
The SETUP menu is displayed.



- 2 Press ▲/▼ to select the desired item.**
The screen will show the current setting for the selected item, and the alternate setting(s).

- Disc Audio (see page 33.)
- Disc Subtitle (see page 33.)
- Disc Menu (see page 33.)
- Rating (see page 34.)
- Password (see page 35.)
- TV Aspect (see page 36.)
- Menu Language (see page 37.)
- Digital Audio Output (see page 38.)
- Others (see page 39.)

- 3 Press ► and then ▲/▼ to select the desired setting and press SELECT/ENTER.**
 - Some items require additional steps. (See their respective page.)

When the alternate setting is selected the screen returns to the Initial Settings display.

To exit SETUP menu

Press SETUP, RETURN or PLAY.

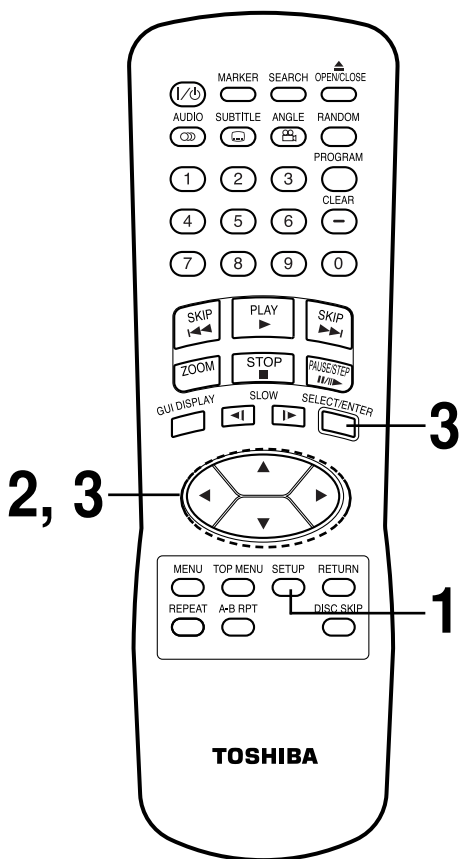

Selecting Disc Languages



To select the audio soundtrack language, subtitle language and the language used in title menus or DVD menus.

When you play back a DVD video disc, the DVD player automatically displays the pre-selected subtitle language if it is included on the disc.

1 At the setup screen, press ▲/▼ to select “Disc Audio” and press ►.



2 Press ▲/▼ to select the desired language and then press SELECT/ENTER.

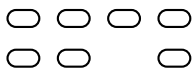

- Original** :The native, or default language of each disc will be selected.
- English** : English will be Selected.
- Other** : Another language can be selected. You can input a 4-digit language code. (Refer to the language codes on page 40. Press CLEAR if an incorrect language code is entered.)

The “Disc Subtitle” and “Disc Menu” settings are selected by the same method.

Note

- If the language selected is not available on the disc, the native, or default language designated by each disc will be selected.



Selecting Rating Level and Password

To prohibit the playing of specified DVDs which are unsuitable for children.

- Some DVD discs contain a restriction level which enables parents to remove scenes or prevent playback of discs by children. DVD players are equipped with a password designed to prevent children from changing the restriction level settings.

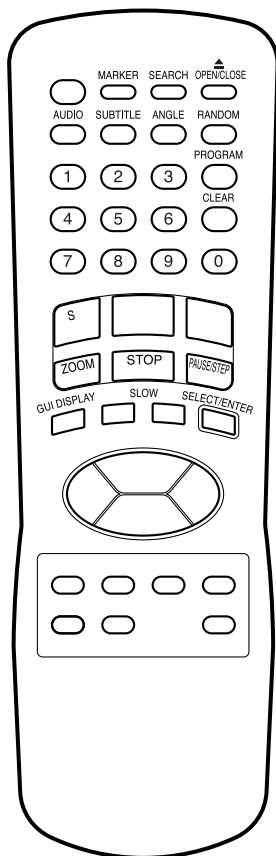

Selecting rating level (DVD only)

- 1 From the **SETUP** screen, press ▲/▼ to select “Rating” and press ►.

Disc Audio	8
Disc Subtitle	7
Disc Menu	6
Rating	5
Password	4
TV Aspect	3
Menu Language	2
Digital Audio Output	1
Others	►Unlock

- 2 Press ▲/▼ to select the desired level and press **SELECT/ENTER**.

Disc Audio	8 Blocked
Disc Subtitle	7 Blocked
Disc Menu	v6
Rating	5
Password	4
TV Aspect	3
Menu Language	2
Digital Audio Output	1
Others	Unlock

You cannot play DVD video discs rated higher than the level you selected unless you cancel the parental lock function. For example, when you select level 7, discs rated higher than level 7 are blocked and cannot be played.

The parental lock level is equivalent to the following USA movie ratings.

Level 7: NC-17 Level 6: R Level 4: PG 13
 Level 3: PG Level 1: G

- Some titles do not match with the rating level described above.

If you change the level and enter a password, playback of all DVDs with ratings higher than your selection will be blocked, unless the correct password is entered again. For example: if you change the level to “5”, the DVD player will not play discs with ratings of “6”, “7” or “8” unless the correct password is entered on the remote control.

For your reference

In order for this DVD Player to maintain a permanent Parental Lock selection, you must enter a 4 digit personal security code.



Setting your password (DVD only)

If you change the rating level to “7” or lower, you must enter a 4-digit “password” to prevent playback of discs with higher ratings.

- 1 At the SETUP screen, press ▼ to select “Password” and press ►.

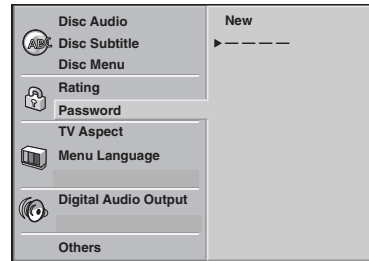

- 2 Input a 4-digit password and press SELECT/ENTER.

Example : 1234

Do not forget your password.

- 3 Input the 4-digit password again and press SELECT/ENTER to verify.

Setting is completed.

- The rating is locked. Any disc whose rating is higher than the setting, cannot be played back unless the correct password is entered, and parental lock level is modified.

To change/clear memorized password

- 1 At the SETUP screen, press ▼ to select “Password” and press ►.

- 2 Input your password and press SELECT/ENTER.

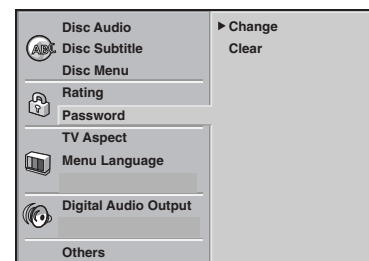

- 3 To change or clear your password, press ▲/▼ to select the “Change” or “Clear” and press SELECT/ENTER.

To change the rating level/password, follow the steps on page 34-35 again.



Selecting TV Aspect

Select the appropriate screen type according to your TV set; conventional size screen (4:3) or wide-screen (16:9).

1 At the **SETUP** screen, press **▲/▼** to select “**TV Aspect**” and press **▶**.

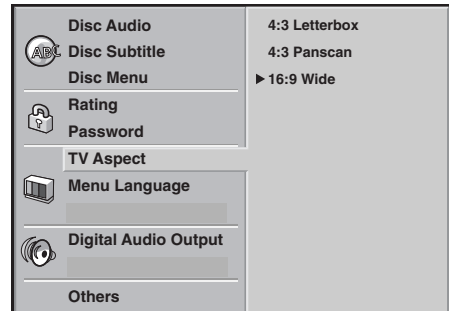
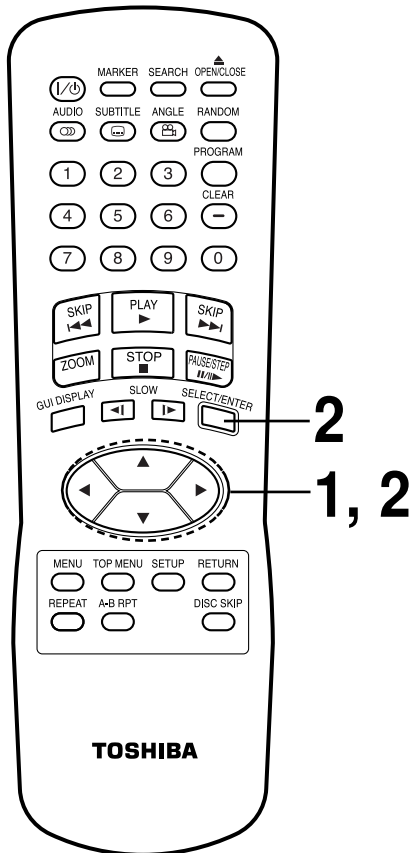

2 Press **▲/▼** to select the desired **Aspect** and press **SELECT/ENTER**.

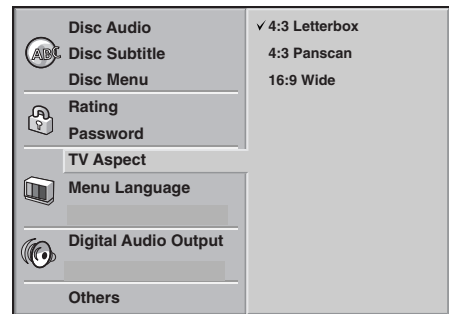

4:3 Letterbox : Select when a conventional TV set is connected widescreen. Video material not formatted to the Pan & Scan style is played back in the letterbox style (black bands appear at top and bottom of screen).

4:3 Panscan : Select when a conventional TV set is connected widescreen. Video material formatted in the Pan & Scan style is played back in that style (Full screen display). However, the left and right edges of the original theatrical presentation will be cropped off.

16:9 Wide : Select when a wide-screen TV set is connected. Played in “FULL” size. (Setting the wide-screen TV to “FULL” mode is also necessary.) Displays a full widescreen picture or slightly letterboxed picture depending upon the aspect ratio of the original theatrical content.

* Each screen shows an example when the video material for a wide-screen is played.



4:3 Letterbox

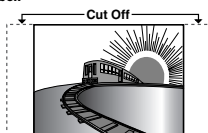

4:3 Panscan



16:9 Wide

Language



UP menus and on-

1

On the SETUP screen, press ▲/▼ to select "Language" and press ►.



2

Press ▲/▼ to select the desired Language and press SELECT/ENTER.





Selecting Digital Audio Output

Each DVD disc has a variety of audio output options. Set the player's Digital Audio Output according to the type of audio system you use.

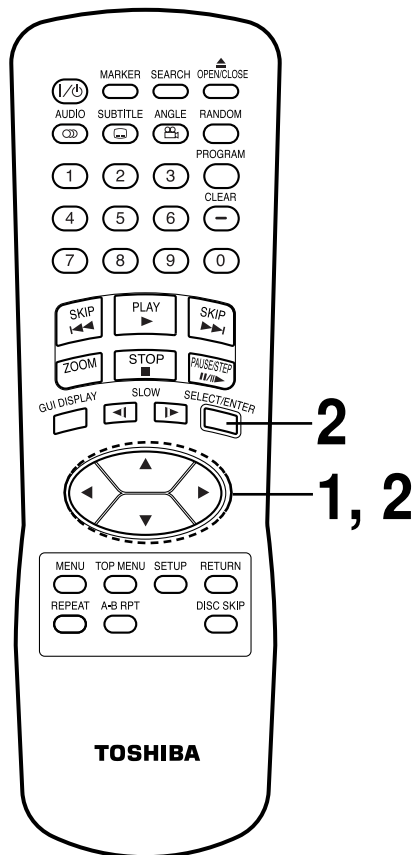

1 At the **SETUP** screen, press **▲/▼** to select **Digital Audio Output** and press **▶**.

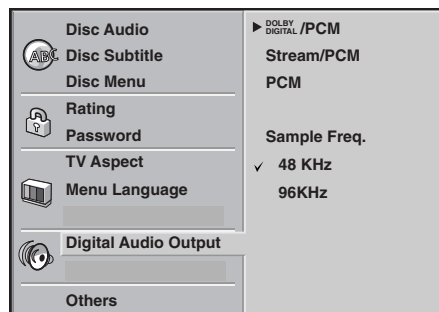

2 Press **▲/▼** to select the desired output and press **SELECT/ENTER**.

You can select Digital Audio Output or Sampling Frequency item by pressing **SELECT/ENTER**.

■ Digital Audio Output

DOLBY DIGITAL/PCM: Select “DOLBY DIGITAL/PCM” if an active digital output is supplied to a Dolby Digital decoder, (or an amplifier or other equipment with Dolby Digital decoder).

Stream/PCM: Select “Stream/PCM” if an active digital output is supplied to an amplifier or other equipment with DTS decoder, Dolby Digital decoder and MPEG decoder.

PCM: Select “PCM” if an active digital output is supplied to an amplifier or other equipment with linear PCM only (or MD recorder or DAT deck).

■ Sampling Frequency

To change the Sample Frequency setting, first select the desired digital audio output type as indicated above. If your A/V receiver or surround processor is NOT capable of handling 96kHz signals, select the 48kHz option. When this choice is made, this unit will automatically convert any 96kHz signals to a 48kHz output so that your system is capable of decoding them.

If your A/V receiver or surround processor is capable of handling 96kHz signals, select the 96kHz option. When this choice is made, this unit will pass each type of signal through without any further processing.

Playback Disc	OUTPUT		
	Stream/PCM	Dolby Digital/PCM	PCM only
96 kHz Linear PCM DVD	PCM	PCM	PCM
DTS DVD	DTS bit Stream	DTS bit Stream	DTS bit Stream
Dolby Digital DVD	Dolby Digital bit Stream	Dolby Digital bit Stream	PCM
MPEG DVD	MPEG bit Stream	PCM	PCM
Audio CD/Video CD	PCM	PCM	PCM
DTS Audio CD	DTS bit Stream	DTS bit Stream	DTS bit Stream

Notes

- When you are not using the player's digital audio output, don't select any of the options.
- If an active digital audio output signal is supplied to a receiver or other equipment without a corresponding digital decoding capability, a very loud noise may be produced which could permanently damage the speakers.
- The DTS DVD disc sound is played back only when the DVD player is connected to a receiver with a DTS decoder.

DR (Dynamic Range Compression)

In DVD format you have the opportunity to listen to the soundtrack in the most accurate and realistic reproduction possible, thanks to the use of digital audio technology. However, in certain instances you may wish to dynamically compress the dynamic range of the audio output (the difference between the loudest sounds and the quietest ones) so that you may listen to a movie at a lower volume and still retain dialogue intelligibility.

- **W** Select Multi-channel karaoke D... being... channels on the di... be r... stereo sound.

- **PBC** Set P... (C) to On...

- On:** V... th...
- Off:** V... played... wa...

Notes

- The DR... during... digital
- The... Com... depending
- The... equipment



Table of Languages and Their Abbreviations



Enter the appropriate code number for the initial settings “Audio”, “Subtitle” and/or “Menu” (See page 33).

Code	Language	Code	Language	Code	Language	Code	Language
6565	Afar	7079	Faroese	7678	Lingala	8375	Slovak
6566	Abkhazian	7082	French	7679	Laothian	8376	Slovenian
6570	Afrikaans	7089	Frisian	7684	Lithuanian	8377	Samoan
6577	Ameharic	7165	Irish	7686	Latvian, Lettish	8378	Shona
6582	Arabic	7168	Scots Gaelic	7771	Malagasy	8379	Somali
6583	Assamese	7176	Galician	7773	Maori	8381	Albanian
6588	Aymara	7178	Guarani	7775	Macedonian	8382	Serbian
6590	Azerbaijani	7185	Gujarati	7776	Malayalam	8385	Sundanese
6665	Bashkir	7265	Hausa	7778	Mongolian	8386	Swedish
6669	Byelorussian	7273	Hindi	7779	Moldavian	8387	Swahili
6671	Bulgarian	7282	Croatian	7782	Marathi	8465	Tamil
6672	Bihari	7285	Hungarian	7783	Malay	8469	Telugu
6678	Bengali; Bangla	7289	Armenian	7784	Maltese	8471	Tajik
6679	Tibetan	7365	Interlingua	7789	Burmese	8472	Thai
6682	Breton	7378	Indonesian	7865	Nauru	8473	Tigrinya
6765	Catalan	7383	Icelandic	7869	Nepali	8475	Turkmen
6779	Corsican	7384	Italian	7876	Dutch	8476	Tagalog
6783	Czech	7387	Hebrew	7879	Norwegian	8479	Tonga
6789	Welsh	7465	Japanese	7982	Oriya	8482	Turkish
6865	Danish	7473	Yiddish	8065	Panjabi	8484	Tatar
6869	German	7487	Javanese	8076	Polish	8487	Twi
6890	Bhutani	7565	Georgian	8083	Pashto, Pushto	8575	Ukrainian
6976	Greek	7575	Kazakh	8084	Portuguese	8582	Urdu
6978	English	7576	Greenlandic	8185	Quechua	8590	Uzbek
6979	Esperanto	7577	Cambodian	8277	Rhaeto-Romance	8673	Vietnamese
6983	Spanish	7578	Kannada	8279	Rumanian	8679	Volapük
6984	Estonian	7579	Korean	8285	Russian	8779	Wolof
6985	Basque	7583	Kashmiri	8365	Sanskrit	8872	Xhosa
7065	Persian	7585	Kurdish	8368	Sindhi	8979	Yoruba
7073	Finnish	7589	Kirghiz	8372	Serbo-Croatian	9072	Chinese
7074	Fiji	7665	Latin	8373	Singhalese	9085	Zulu

Disc Requirements/Copyright Information

Playable Discs

This DVD player can play back the following discs.

	Disc mark	Contents	Disc size	Maximum playback time
DVD video discs		Audio+Video (moving pictures)	12 cm	Approx. 4 hours (single sided disc)
				Approx. 8 hours (double sided disc)
			8 cm	Approx. 80 minutes (single sided disc)
				Approx. 160 minutes (double sided disc)
Video CDs		Audio+Video	12 cm	74 minutes
			8 cm	20 minutes
Audio CDs		Audio	12 cm	74 minutes
			8 cm	20 minutes

CD-R/RW discs are also available.

You cannot playback discs other than those listed above. (CD-ROM, CD-Extra, CD-G, photo CD, and CD-i discs can not be played on this DVD player.)

CD-R/RW discs recorded by CD-DA method can be played. Some CD-R/RW discs may be incompatible.

You cannot play discs of DVD-RAM, DVD-RW, etc., even if they may be labeled marks listed above.

Region Management Information

Region Management Information: This DVD Player is designed and manufactured to respond to the Region Management Information that is recorded on a DVD disc. If the Region number described on the DVD disc does not correspond to the Region number of this DVD player, this DVD player cannot play that disc.

The Region number of this DVD player is 1.



Notes on Unauthorized Discs

You may not be able to play back some DVD video discs on this player if they were purchased from outside your geographic area or made for business purposes.

When you try to play back an unauthorized disc, "**Check Regional Code**" appears on the TV screen.

Notes on Copyright

It is forbidden by law to copy, broadcast, show, broadcast on cable, play in public, and rent copyrighted material without permission.

DVD video discs are copy protected, and any recordings made from these discs will be distorted.

This product incorporates copyright protection technology that is protected by method claims of certain U.S. patents and other intellectual property rights owned by Macrovision Corporation and other rights owners. Use of this copyright protection technology must be authorized by Macrovision Corporation, and is intended for home and other limited viewing uses only, unless otherwise authorized by Macrovision Corporation. Reverse engineering or disassembly is prohibited.

Before Calling Service Personnel

Symptoms and Correction

Check the following guide for the possible cause of a problem before contacting service.

Symptom	Cause	Correction
No power.	<ul style="list-style-type: none"> The power cord is disconnected. 	<ul style="list-style-type: none"> Plug the power cord into the wall outlet securely.
The power is on, but the DVD player does not work.	<ul style="list-style-type: none"> No disc is inserted. 	<ul style="list-style-type: none"> Insert a disc. (Check that the DVD or, audio CD indicator in the DVD display is lit.)
No picture.	<ul style="list-style-type: none"> The TV is not set to receive DVD signal output. 	<ul style="list-style-type: none"> Select the appropriate video input mode on the TV so the picture from the DVD player appears on the TV screen.
	<ul style="list-style-type: none"> The video cable is not connected securely. 	<ul style="list-style-type: none"> Connect the video cable into the jacks securely.
	<ul style="list-style-type: none"> The connected TV power is turned off. 	<ul style="list-style-type: none"> Turn on the TV.
No sound.	<ul style="list-style-type: none"> The equipment connected with the audio cable is not set to receive DVD signal output. 	<ul style="list-style-type: none"> Select the correct input mode of the audio receiver so you can listen to the sound from the DVD player.
	<ul style="list-style-type: none"> The audio cables are not connected securely. 	<ul style="list-style-type: none"> Connect the audio cable into the jacks securely.
	<ul style="list-style-type: none"> The power of the equipment connected with the audio cable is turned off. 	<ul style="list-style-type: none"> Turn on the equipment connected with the audio cable.
	<ul style="list-style-type: none"> The Digital Audio Output is set to the wrong position. 	<ul style="list-style-type: none"> Set the Digital Audio Output to the correct position, then turn on the DVD player again by pressing the POWER button.
The playback picture is poor.	<ul style="list-style-type: none"> The disc is dirty. 	<ul style="list-style-type: none"> Clean the disc.
The DVD player does not start playback.	<ul style="list-style-type: none"> No disc is inserted. 	<ul style="list-style-type: none"> Insert a disc. (Check that the DVD, or audio CD indicator in the DVD display is lit.)
	<ul style="list-style-type: none"> An unplayable disc is inserted. 	<ul style="list-style-type: none"> Insert a playable disc. (Check the disc type, color system and Regional code.)
	<ul style="list-style-type: none"> The disc is placed upside down. 	<ul style="list-style-type: none"> Place the disc with the playback side down.
	<ul style="list-style-type: none"> The disc is not placed within the guide. 	<ul style="list-style-type: none"> Place the disc on the disc tray correctly inside the guide.
	<ul style="list-style-type: none"> The disc is dirty. 	<ul style="list-style-type: none"> Clean the disc.
	<ul style="list-style-type: none"> A menu is on the TV screen. 	<ul style="list-style-type: none"> Press the SETUP button to turn off the menu screen.
The remote control does not work properly.	<ul style="list-style-type: none"> The remote control is not pointed at the remote sensor of the DVD player. 	<ul style="list-style-type: none"> Point the remote control at the remote sensor of the DVD player.
	<ul style="list-style-type: none"> The remote control is too far from the DVD player. 	<ul style="list-style-type: none"> Operate the remote control within about 23 ft (7 m).
	<ul style="list-style-type: none"> There is an obstacle in the path of the remote control and the DVD player. 	<ul style="list-style-type: none"> Remove the obstacle.
	<ul style="list-style-type: none"> The batteries in the remote control are exhausted. 	<ul style="list-style-type: none"> Replace the batteries with new ones.

Specifications

DVD player/Outputs/Supplied Accessories

[DVD player]	Power supply	AC 120V, 60 Hz
	Power consumption	16 W
	Weight	12.6 lbs (5.7 kg)
	External dimensions (W X H X D)	17" X 4.7" X 15.1" (430 x 118 x 381 mm)
	Signal system	NTSC
	Laser	Semiconductor laser, wavelength 650 nm (DVD), 780 nm (CD)
	Frequency range (audio)	4 Hz to 20 kHz
	Signal-to-noise ratio (audio)	More than 100 dB (EIAJ)
	Dynamic range (audio)	More than 90 dB (EIAJ)
	Harmonic distortion (audio)	0.008 %
	Wow and flutter	Below measurable level (less than + 0.001 % (W.PEAK)) (EIAJ)
	Operating conditions	Temperature: 41°F to 95°F, Operation status: Horizontal
[Outputs]	Video output	1.0 V (p-p), 75 Ω, negative sync., RCA jack x 1
	S-video output	(Y) 1.0 V (p-p), 75 Ω, negative sync., Mini DIN 4-pin x 1 (C) 0.286 V (p-p), 75 Ω
	Component video output	(Y) 1.0 V (p-p), 75 Ω, negative sync., RCA jack x 1 (Pb)/(Pr) 0.7 V (p-p), 75 Ω
	Audio output (digital audio)	0.5 V (p-p), 75 Ω, RCA jack x 1
	Audio output (analog audio)	2.0 Vrms(1 KHz, 0 dB), 330 Ω, RCA jack (L, R) x 2
[Supplied Accessories]	<ul style="list-style-type: none"> ● Video cable1 ● Audio cable1 ● Remote control.....1 ● Batteries2 	

* Designs and specifications are subject to change without notice.

LIMITED WARRANTY DVD VIDEO PLAYER

Toshiba America Consumer Products, Inc. ("TACP"), Toshiba Hawaii ("THI") and Toshiba Canada Limited ("TCL") make the following limited warranties. These limited warranties extend to original purchaser or any person receiving this set as a gift from the original purchaser and to no other purchaser or transferee.

Limited Ninety (90) Day Warranty

TACP/THI warrant this product against defects in materials or workmanship for a period of ninety (90) days after the date of original retail purchase. During this period, TACP/THI will repair or replace a defective product or part, at their option, with a new or refurbished product or part without charge to you. You must deliver the entire product to a TACP/THI Authorized Service Station. You are responsible for all transportation and insurance charges for the unit to and from the Authorized Service Station. If you live in the U.S.A. you may, at your option, return your DVD Unit to:

Toshiba America Consumer Products Inc.
Returns Center
1420C Toshiba Dr.
Lebanon, TN 37087

Upon receipt we will, at our option, exchange the DVD Unit with a new or refurbished unit. **Canadian consumers are requested to contact TCL. In Hawaii consumers are requested to contact THI.**

Limited One (1) Year Warranty

TACP/THI further warrant the parts in this product against defects in materials or workmanship for a period of one (1) year after the date of original retail purchase. During this period, TACP/THI will repair or replace a defective product or part, at their option, with a new or refurbished product or part without charge to you, except that if a defective part is replaced after ninety (90) days from the date of the original retail purchase you pay labor charges involved in the replacement. You must also deliver the entire product to a TACP/THI Authorized Service Station. You are responsible for all transportation and insurance charges for the unit to and from the Authorized Service Station. If you live in the U.S.A. you may, at your option, return your DVD Unit to:

Toshiba America Consumer Products Inc.
Returns Center
1420C Toshiba Dr.
Lebanon, TN 37087

Upon receipt we will, at our option, exchange the DVD Unit with a new or refurbished unit. **Canadian Consumers are requested to contact TCL. In Hawaii consumers are requested to contact THI.**

Rental Units

The warranty for rental units begin with the first rental or thirty (30) days from the date of shipment to the rental firm, whichever comes first.

Commercial Units

Products sold and used for commercial use have a limited ninety (90) day warranty for all parts and labor.

Owner's Manual

You should read the owner's manual thoroughly before operating this product. You should complete and mail the enclosed Demographic card within ten (10) days after you, or the person who has given you this product as a gift, purchased this product. This is one way to enable TACP to provide you with better customer service and improved products. Failure to return the card will not affect your rights under this warranty.

Your Responsibility

The above warranties are subject to the following conditions:

- (1) You must retain your bill of sale or provide other proof of purchase.
- (2) You must notify a TACP/THI/TCL /Authorized Service Station within thirty (30) days after you discover a defective product or part.
- (3) All warranty servicing of this product must be made by a TACP/THI/TCL Authorized Service Station.
- (4) U.S.A. warranties are effective only if the product is purchased and operated in the Continental U.S.A. or Puerto Rico.
- (5) Labor service charges for set installation. Set up, adjustment of customer controls and installation or repair of antenna systems are not covered by this warranty. Reception problems caused by inadequate antenna systems are your responsibility.
- (6) Warranties extend only to defects in materials or workmanship as limited above and do not extend to any product or parts which have been lost or discarded by you or to damage to products or parts caused by misuse, accident, damage caused by Acts of God, such as lighting or fluctuations in electric power, improper installation, improper maintenance or use in violation of instructions furnished by us; or to units which have been altered or modified without authorization of TACP/THI/TCL or to damage to products or part thereof which have had the serial number removed, altered, defaced or rendered illegible.
- (7) Should you elect to return your DVD Unit to TACP after the ninety (90) days and within one (1) year, or after the warranty period has expired: Call (800)-631-3811 to receive information concerning an exchange price. Payment must be enclosed with product in the form of a certified check or money order including reason for return.
- (8) Physically damaged DVD Units are not acceptable for repair or exchange whether in or out of warranty and will be returned as received.

(Continued)

LIMITED WARRANTY DVD VIDEO PLAYER (Cont'd)**How to Obtain Warranty Service**

- (1) Refer to the troubleshooting guide in your owner's manual. This check list may solve your problem.
- (2) In the U.S.A., only call the TACP toll free number 800-631-3811, or if in Hawaii or Canada see listing below within (30) days after you find a defective product or part.
- (3) Arrange for the delivery of the product to the TACP/THI/TCL Authorized Service Station or TACP Return Center. Products shipped to the Service Station must be insured and safely and securely packed, preferably in the original shipping carton, and a letter explaining the defect and also a copy of the bill of sale or other proof of purchase must be enclosed.

In the Continental United States contact:**In Hawaii contact:**

Toshiba Hawaii Inc.
327 Kamakee Street
Honolulu, HA 96814
(808)-521-5377

In Canada contact:

Consumer Electronics Group
191 McNabb Street
Markham, Ontario L3R 8H2
(905)-470-5400

Consumer Electronics Group
22171 Fraserwood Way
Richmond, B.C. V6W 1J5
(604)-303-2500

Consumer Electronics Group
1643 North Service Road
Droval, QC H9P 1J1
(514)-856-4100

All warranties implied by state law, including the implied warranties of merchantability and fitness for a particular purpose, are expressly limited to the duration of the limited warranties set forth above. With the exception of any warranties implied by state law as hereby limited, the foregoing warranty is exclusive and in lieu of all other warranties, guarantees, agreements and similar obligations of manufacturer or seller with respect to the repair or replacement of any parts. In no event shall TACP/THI be liable for consequential or incidental damages.

No person, agent, distributor, dealer or company is authorized to change, modify or extend the terms of these warranties in any manner whatsoever. The time within which an action must be commenced to enforce any obligation of TACP/THI arising under the warranty or under any statute, or law of the United States or any state thereof, is hereby limited to ninety (90) days from the date you discover or should have discovered, the defect. This limitation does not apply to implied warranties arising under state law. This warranty gives you specific legal rights and you may also have other rights which may vary from state to state. Some states do not allow limitation on how long an implied warranty lasts, when an action may be brought, or the exclusion or limitation of incidental or consequential damages, so the above provisions may not apply to you.

ATTENTION CANADIAN CONSUMERS:

Canadian consumers are requested to complete the special Canadian "Warranty Registration Form" enclosed, and forward this completed form with a copy of bill of sale to TOSHIBA OF CANADA to "Register and Validate" their warranty. Product must be purchased from an Authorized Canadian Dealer. Products purchased in the U.S.A. and used in Canada are not covered by these warranties.

IMPORTANT: PACKING AND SHIPPING INSTRUCTION

When you send the product to a Service Station, you must use the original carton box and packing material, then insert the original carton box containing the unit into another carton using more packing material.

TOSHIBA